

PORTFOLIO  
1970  
2015

esteva  
barcelona

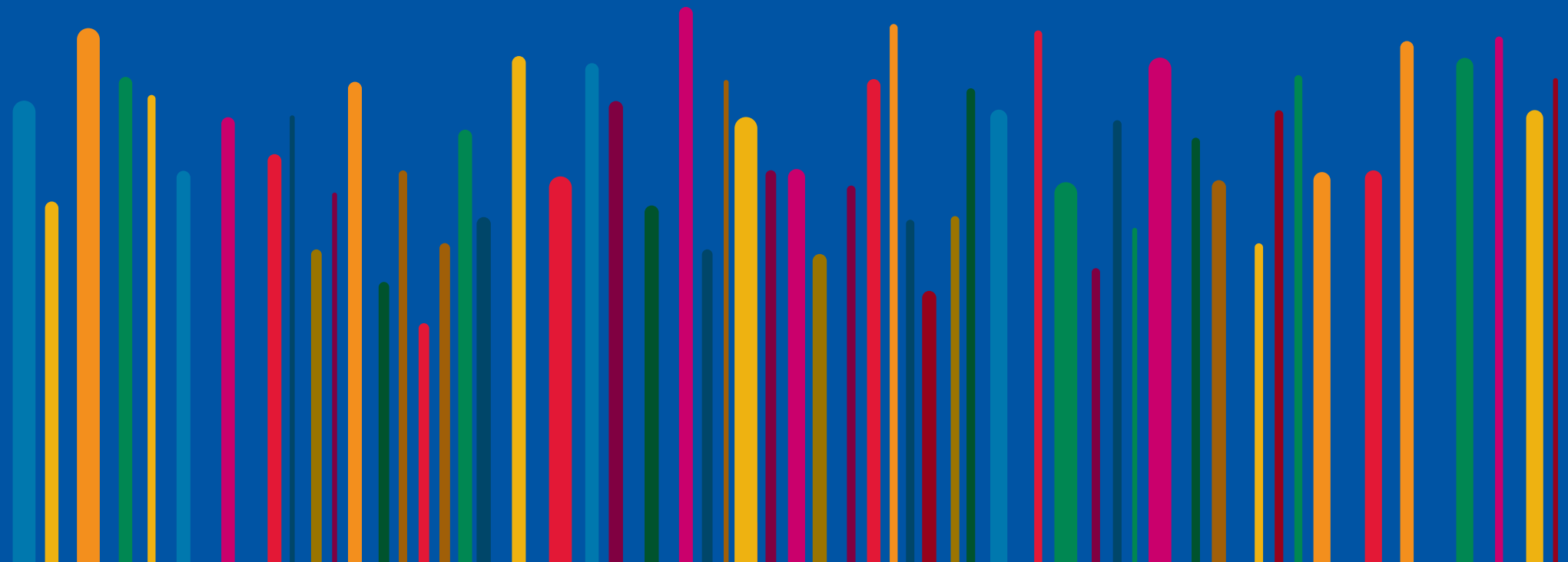



**Accesible** / Accessible / Accessibilité

доступный

无障碍设计 / متاح لمتحدى الإعاقة



**Selección Materiales** / Procurement / Selection de Matériaux

Набор материалов

材料选择 / انتقاء مواد التصنيع



**Diseño e Ingeniería** / Design and Engineering / Design et Ingénierie

Дизайн и проектирование

设计与制造 / تصميم و اعمال هندسية



**Nuevo** / New / Neuf

Новый

崭新的 / جديد



**Aire acondicionado** / Air Conditioned / Climatisation

Кондиционер

空调设计 / تكييف هواء



**Fotovoltaico** / Photovoltaic / Photovoltaïque

фотогальванический

太阳能



AUT

**Automático** / Automatic / Automatique

автоматика

自动系统 / اوتوماتيك



**Bioclimático** / Bioclimatic / Bioclimatique

Биоклимат

环境设计



**Aluminio reciclado** / Recycled aluminium / Aluminium Recyclé

Переработанный алюминий

循环再造铝 / الومنيوم معاد تدويره



**Madera** / Wood / Bois

Переработанный материал из дерева

循环再造木材 / اخشاب معاد تدويرها



**Poliéster** / Polyester / Polyester

Полиэстер

聚酯纤维 / بوليستر



**Acero inoxidable** / Stainless steel / Acier inoxydable

Нержавеющая сталь

不锈钢 / ستانلس ستيل



**Aluminio** / Aluminium / Aluminium

Повторно

循环再造铝 / الومنيوم معاد تدويره



**70% Madera / Wood / Bois - 30% Polypropilene - 100% Reciclable** / "Cradle to cradle"

Переработанный материал из дерева

循环再造木材 / اخشاب معاد تدويرها

## PROYECTOS DESTACADOS / HIGHLIGHTED PROJECTS 03

PROJETS SOULIGNÉES

Выдающиеся проекты

相关项目

مشاريح مميزة

## QUIOSCOS / KIOSKS 11

KIOSQUES

Киоски

报纸亭, 报摊

اكشاك

## LÚDICO Y JUEGOS / PLAYGROUND 33

AIRE DE JEUX

Игровые и спортивные площадки

儿童游戏设施

العاب / حدائق اطفال

## MOBILIARIO URBANO / URBAN FURNITURE 37

MOBILIER URBAIN

обустройство городского ландшафта

街道设施

اثات خارجى للمدن

## SOMBRA / SHADOW 47

OMBRE

тенты

遮阳设施

ظلال

## ARTE PÚBLICO / PUBLIC ART 53

ART PUBLIC

Арт публика

大众艺术

فنون جماهيرية

## ESPACIO CORPORATIVO / CORPORATE 57

CORPORATIVE

история

我们的历史

تاريخ



**PROYECTOS DESTACADOS / HIGHLIGHTED PROJECTS**

PROJETS SOULIGNÉES

Выдающиеся проекты

相关项目

مشاريع مميزة

**Name of the project:**  
MUSEUM OF ISLAMIC ART PARK  
(MIA PARK)

**Client:**  
QATAR MUSEUMS AUTHORITY

**Design:**  
PPA ARCHITECTS / ESTEVA

**Location:**  
Doha , Qatar

**Date:**  
2011

**Our scopes:**  
Diseño, construcción e instalación  
Design, build and installation



## PEI PARTNERSHIP ARCHITECTS

11 June 2012

To whom it may interest,

We are glad to confirm that we have designed the hospitality and souvenir kiosks and public toilets in the project "MUSEUM OF ISLAMIC ART PARK" in Doha (Qatar). Our design was further developed in collaboration with Esteva and fabricated by Esteva in Barcelona (Spain) with the supervision and coordination of our team in New York and these works took all year 2011. Esteva led the installation works in Doha in December 2011 and all the interior design and operational layout.

All these works have fulfilled all our expectations and quality requirements both in design assessment, materials, document handling, execution and schedule.

Sincerely,  
Pei Partnership Architects LLP

A handwritten signature in black ink, reading "Chien Chung Pei".

Chien Chung Pei  
Partner

Pei Partnership Architects LLP  
257 Park Avenue South  
New York New York  
10010-7304  
Tel 212 674 9000  
Fax 212 674 5900  
www.peipartnership.com



هيئة متاحف قطر  
QATAR MUSEUMS AUTHORITY

August 5, 2012

To whom it may concern,

It was with great pleasure to have the opportunity to work with real professionals on the Museum of Islamic Art Park project in Doha, Qatar.

ESTEVA Barcelona of Spain was the supplier, fabricator, installer and maintenance team whom were introduced by our architect, Pei Partnership Architects LLP of New York, New York, USA, for our outdoor kiosk outlets of café, pastry shop, gift shop and toilet facilities.

The project was of huge success upon opening, and the design and execution of the kiosks are all well received by our customers and we are very proud to have these outlets available for the general public use.

Aside from the park kiosks, we have continued to contract ESTEVA for other projects directly for our continued portfolio of services, especially under our Enterprise Group. Some others include a café for our recent Takashi Murakami exhibition in Al Riwaq, Doha, Qatar, whereas ESTEVA was contracted to be our designer, supplier, fabricator, installer and project management for turn-key service. They completed on budget and on schedule.

We look forward to future projects with ESTEVA.

Very truly yours,

Jasper H. Hwang

Director of Special Projects  
Office of H.E. Chairperson  
Qatar Museums Authority

هاتف : 4425555 - فاكس : 4859739 ص. ب. : 2777، الدوحة - قطر الموقع الإلكتروني www.qma.com.qa  
Tel.: 4525555 - Fax : 4859739 - P.O. Box : 2777 - Doha - Qatar Web.: www.qma.com.qa

**Name of the project:**  
AL RIWAQ CAFÉ  
CAFETERÍA TEMATIZABLE  
THEMATISABLE CAFÉ

**Client:**  
QATAR MUSEUM AUTHORITY

**Design:**  
INSIGHT STUDY - ESTEVA

**Location:**  
Al Riwaq Exhibition Hall, Doha (Qatar)

**Date:**  
2012

**Our scopes:**  
Diseño de cafetería tematizable según la exposición en curso. Fabricación, instalación y servicio post venta.  
Design of customizable coffee shop according to exhibition themes.



**Name of the project:**  
PONT DU GARD  
KIOSCO BIENVENIDA  
WELCOME KIOSK / QUIOSQUE ACUEIL

**Client:**  
MAIRIE DE PONT DU GARD (FRANCE)

**Design:**  
SUPER

**Location:**  
Pont du Gard (France)

**Date:**  
2013

**Our scopes:**  
Diseño y construcción, instalación y servicio post venta  
Design and build, installation and post sale service



**Name of the project:**  
TOLEDO  
TIENDA Y TAQUILLA EXPOSICIÓN GRECO

**Location:**  
Museo de Santa Cruz, Toledo (Spain)

**Date:**  
2014

**Our scopes:**  
Construcción e instalación  
Building and installation





**Name of the project:**  
NEW AIRPORT OF DOHA  
ILLUMINATED URBAN FURNITURE FOR  
NEW INTERNATIONAL AIRPORT OF DOHA

**Client:**  
AL NAKHEEL

**Design:**  
NDIA

**Location:**  
Ndia Green Walk

**Date:**  
2013

**Our scopes:**  
Diseño, construcción e instalación  
Design and build, installation



QUIOSCOS / KIOSKS

KIOSQUES

Киоски

报纸亭, 报摊

اكشاك

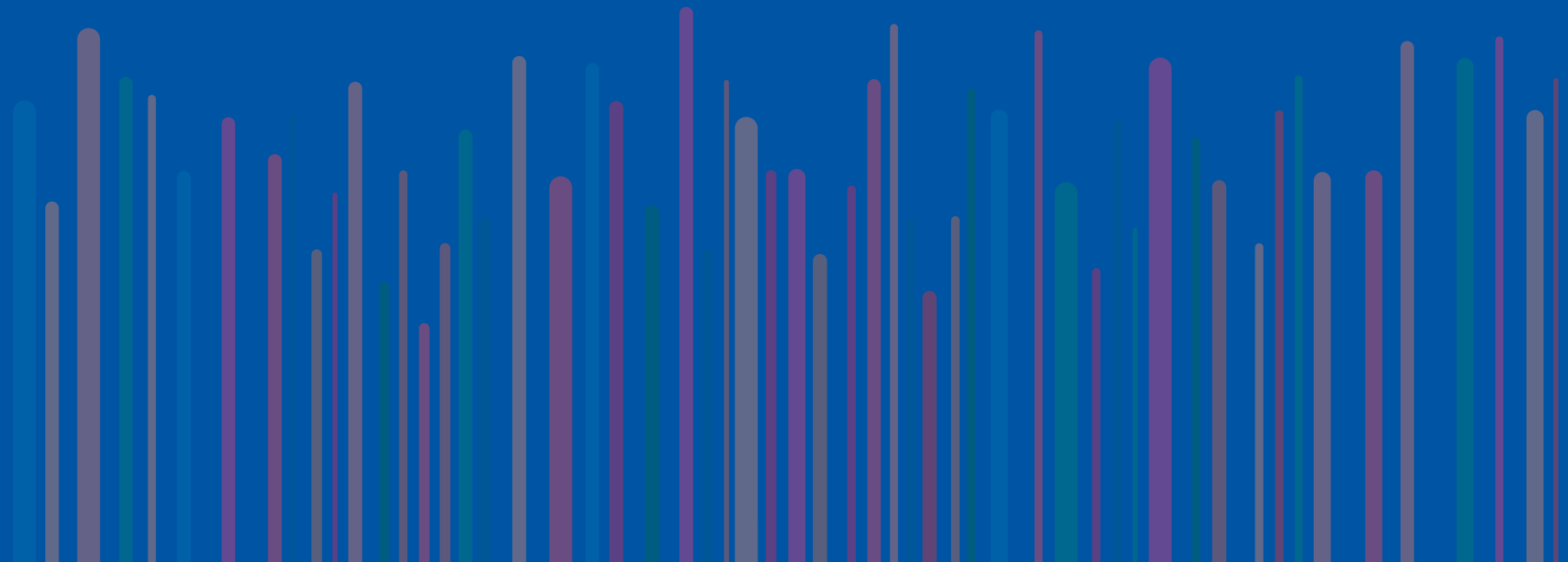





## ECO UMP

Antoni Roselló



SelecciónAdi-Fad 2007  
Adi Fad Prize Selection



Design Award  
of the Federal Republic  
of Germany

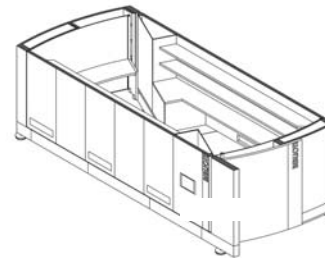

Cerrado / Closed / Fermé / Öffren

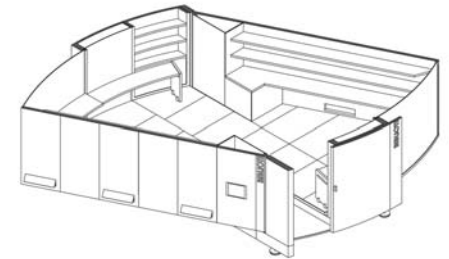
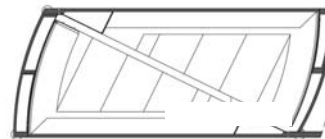

Abierto / Open / Ouvert / Geschlossen

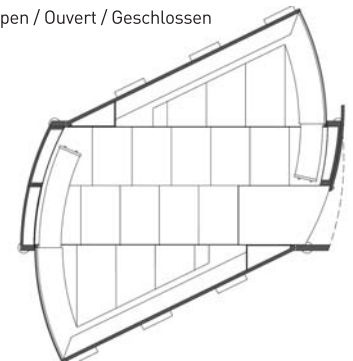



Bilbao Arena

Informazioa  
Información

Leihatila  
Taquilla

APERTURA DE TAQUILLA  
10:00 horas del comienzo del partido

B  
26-27  
2  
6-7  
1

esteva  
barcelona



UMP

Antoni Roselló



Delta de Plata Adi-Fad 2003  
Adi Fad Delta de Plata 2003

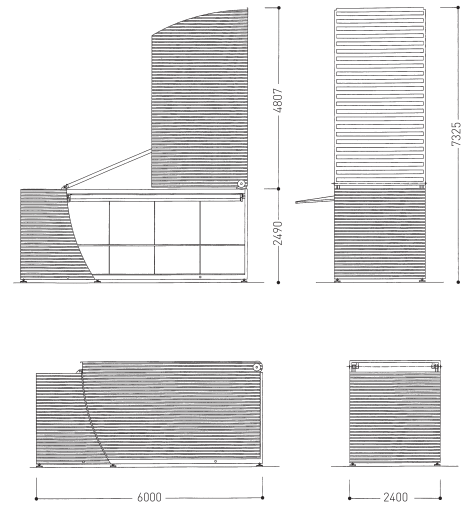



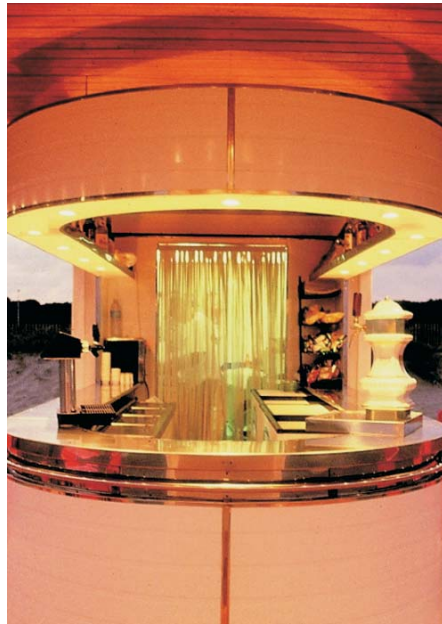

UMB

Antoni Roselló



Delta de Plata Adi-Fad 1993  
Adi Fad Delta de Plata 1993

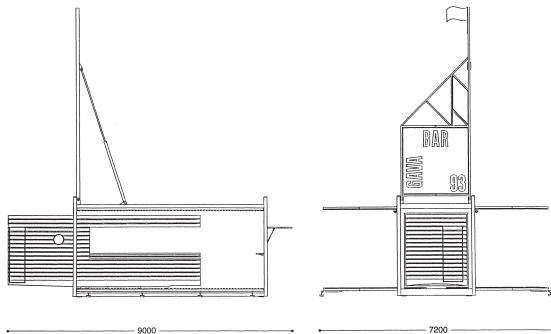

Abierto / Open / Ouvert / Geschlossen

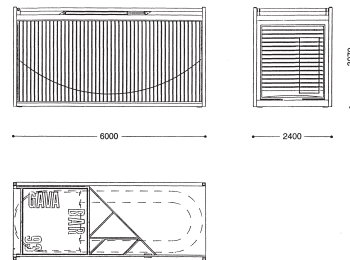

Cerrado / Closed / Fermé / Öffnen







UMD

Antoni Roselló

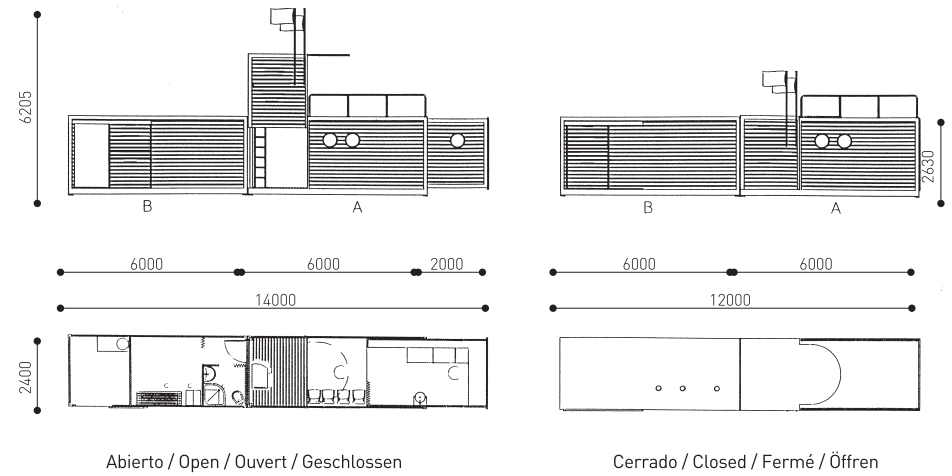





Dexeus

Antoni Roselló

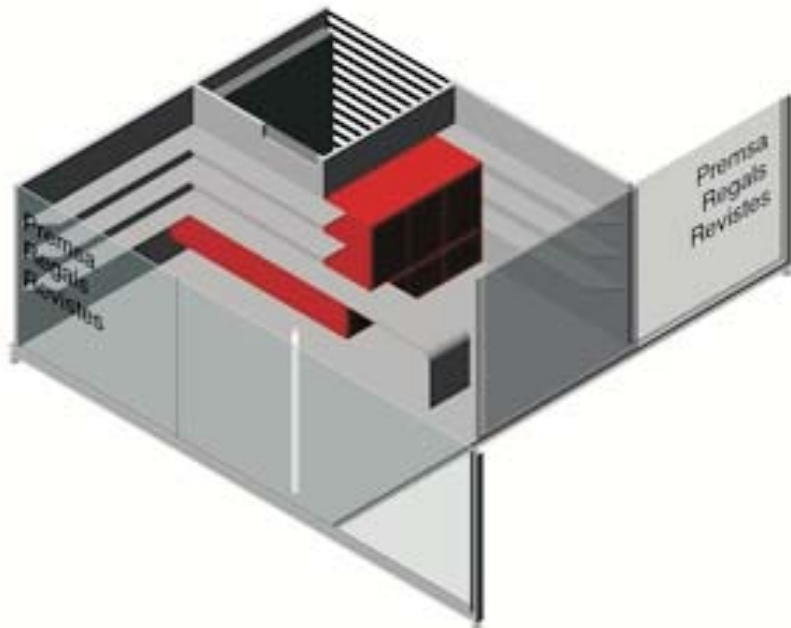



Circular

Antoni Roselló

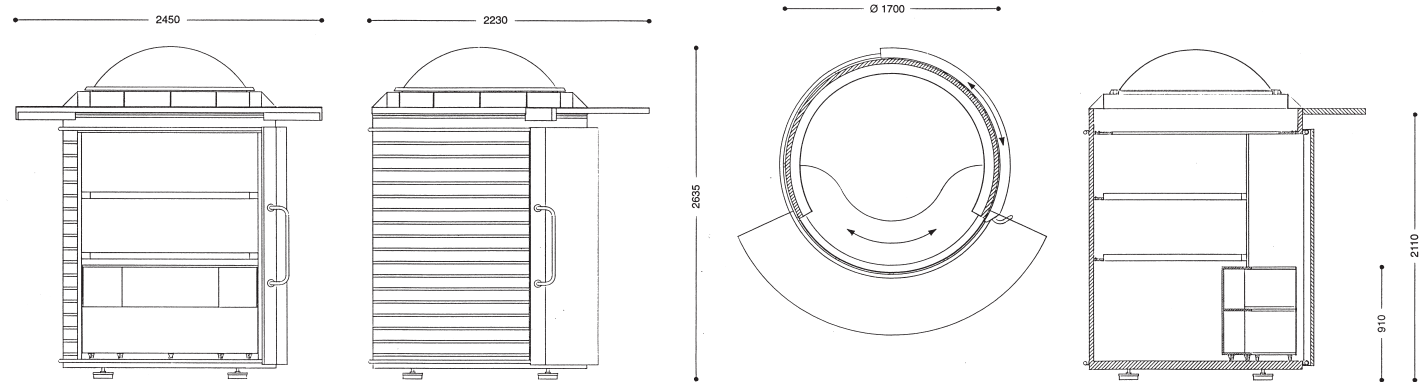



# Fira

Antoni Roselló

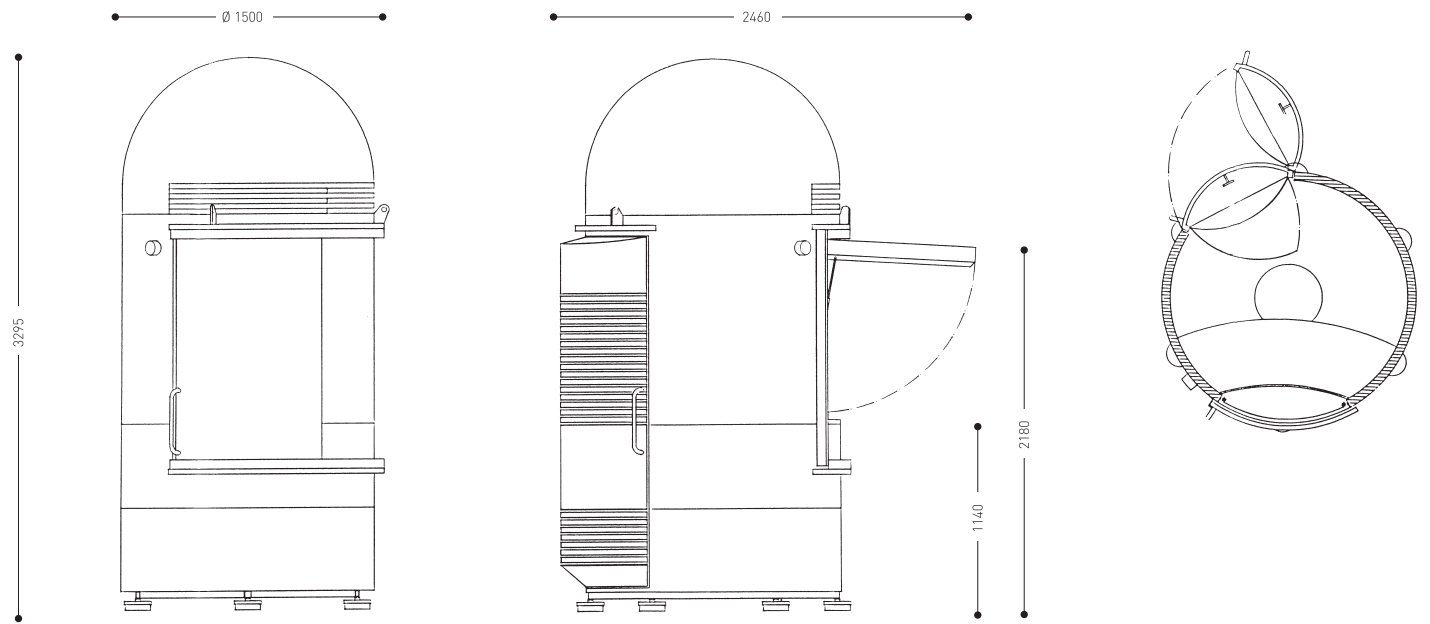



Barcelona

Antoni Roselló

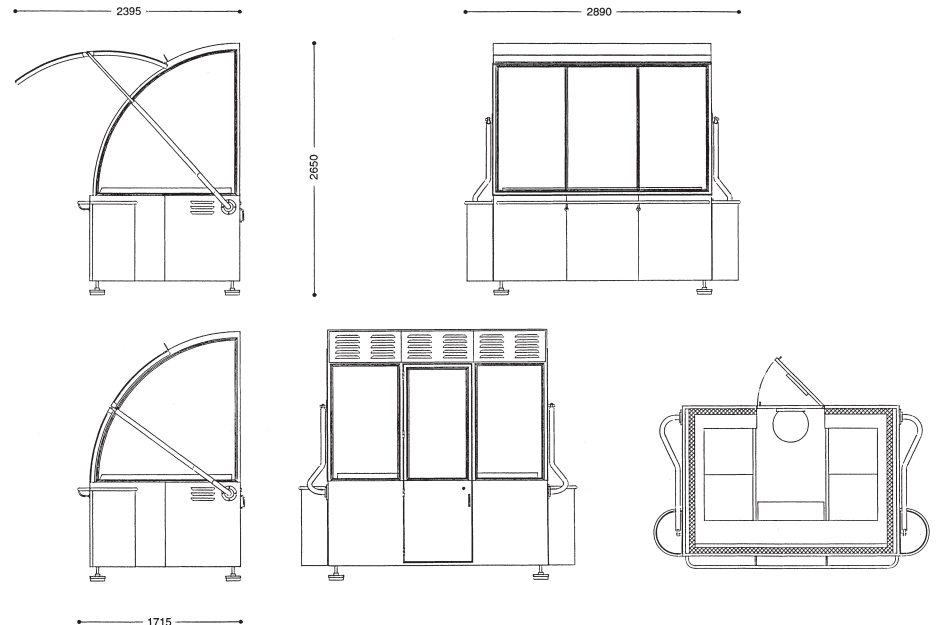
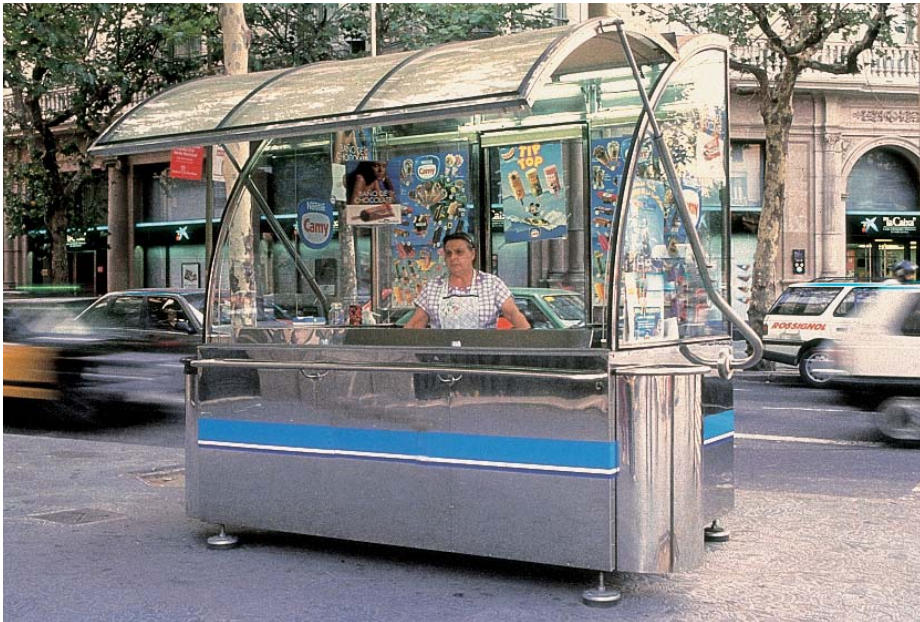



Dino

Antoni Roselló



**CUADRADO/SQUARE**

Apertura/opening: 1, 2, 3 lados/sides

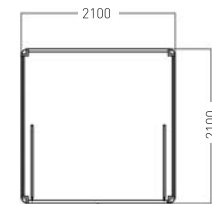
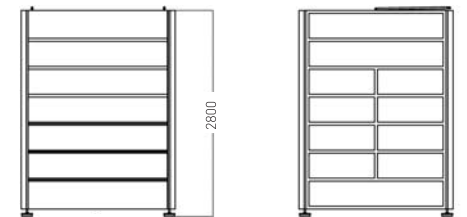



Laika

Antoni Roselló



Selección Adi-Fad 1991  
Adi Fad Prize Selection

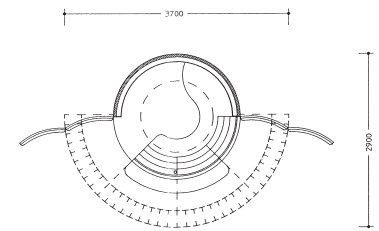
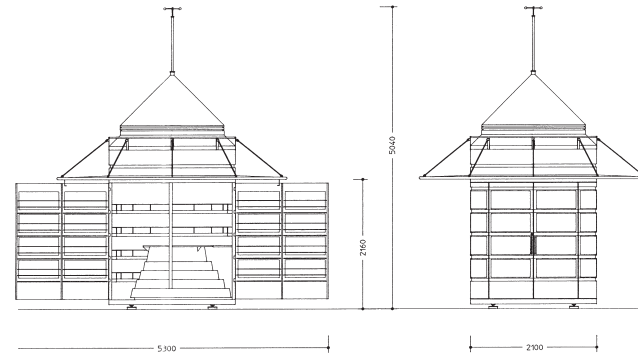



CuVe

Esteva

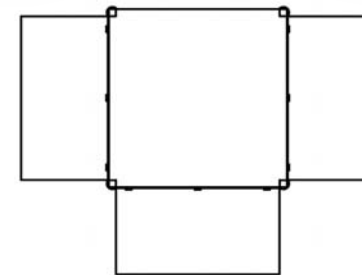
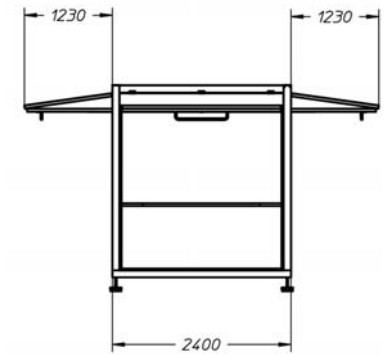
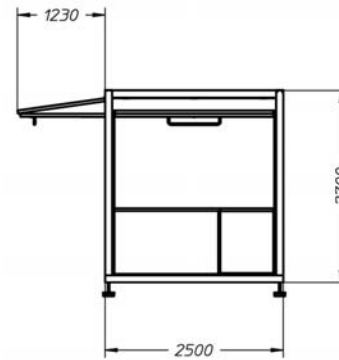



Blanes

Ajuntament de Blanes

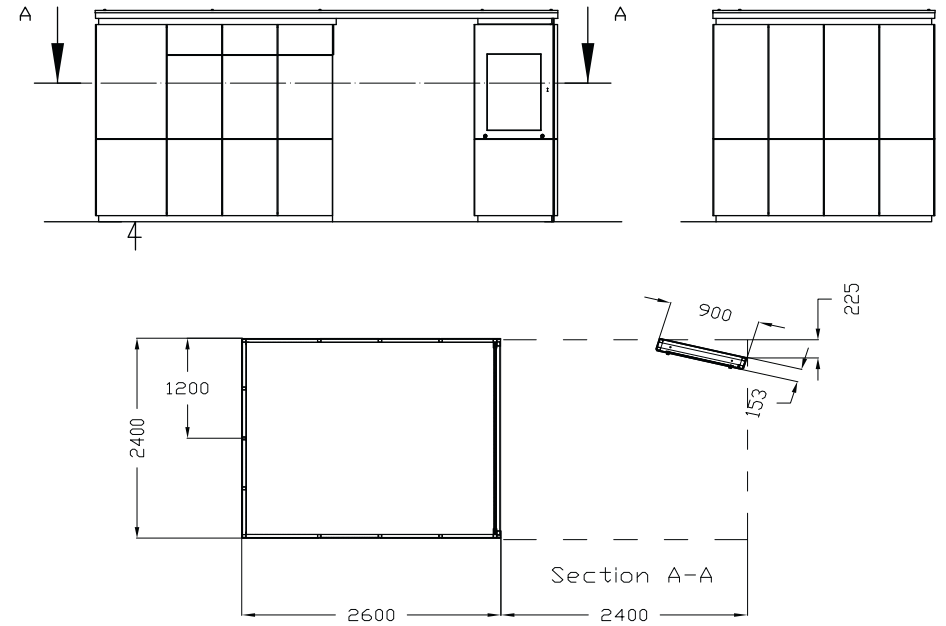

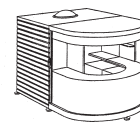

A + C L=4 m.

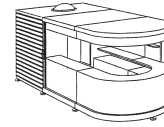

A + B + C L=6 m.

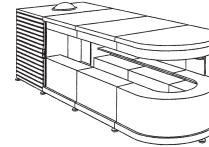

A + B + B + C L=8 m.

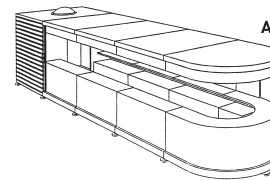

A + B + B + B + C L=10 m.

Fast

Antoni Roselló



Abierto / Open / Ouvert / Geschlossen

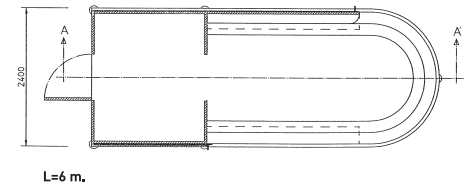
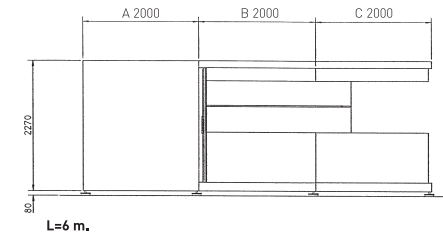

Cerrado / Closed / Fermé / Öffren

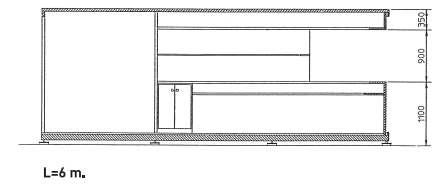
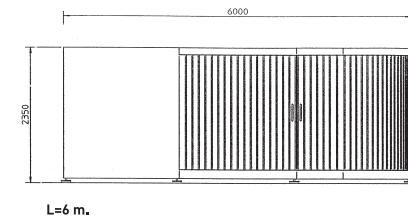





## WC Configurable

Esteva



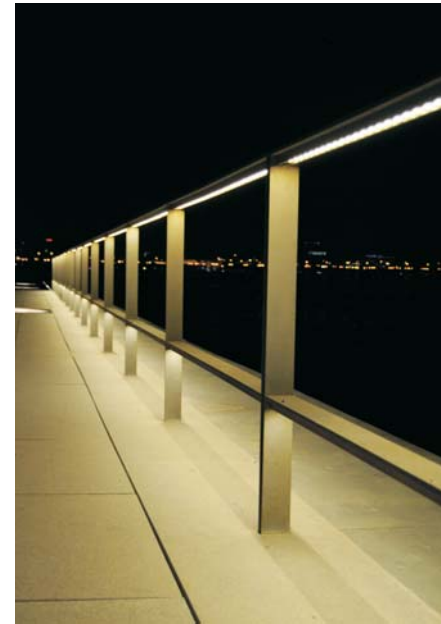

## Barandilla Led - Led Handrail

Okamoto

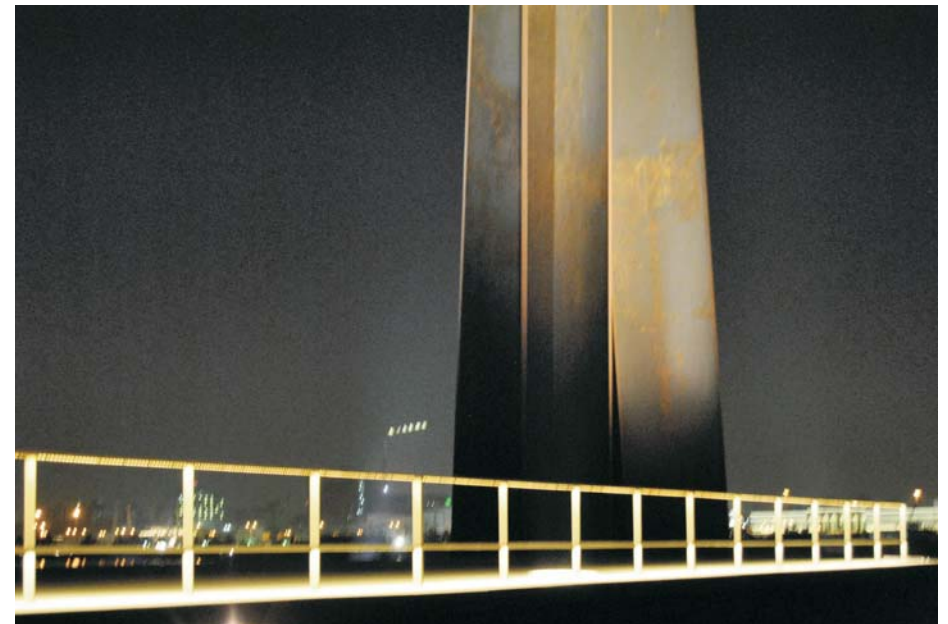
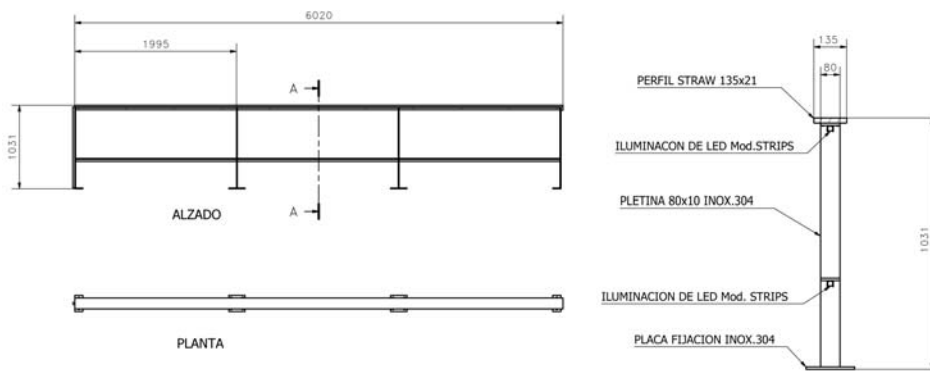

# LÚDICO Y JUEGOS / PLAYGROUND

AIRE DE JEUX

Игровые и спортивные площадки

儿童游戏设施

العاب / حدائق اطفال

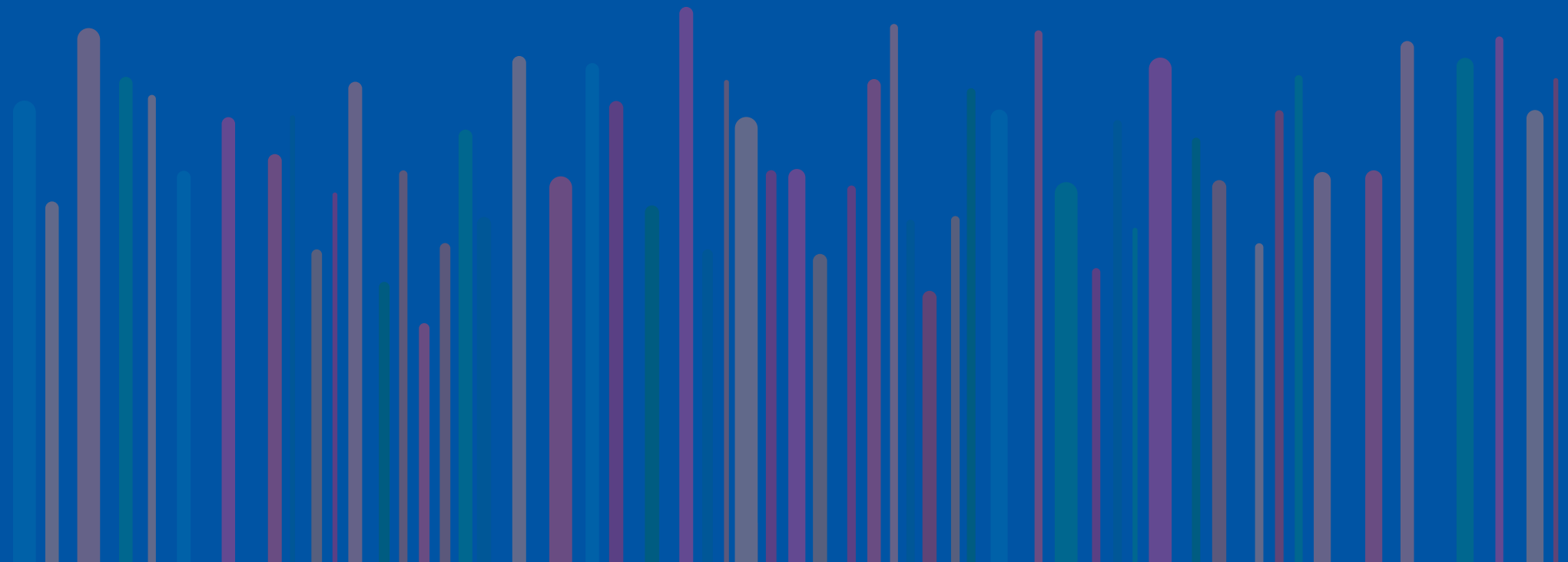



Mowgli

Antoni Roselló

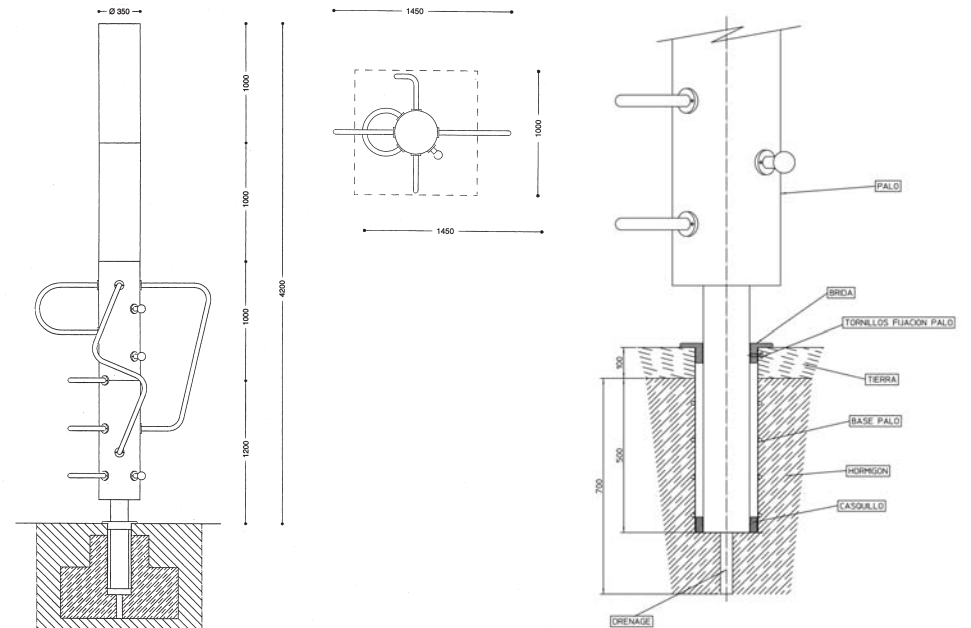



Mix Mix

Antoni Roselló

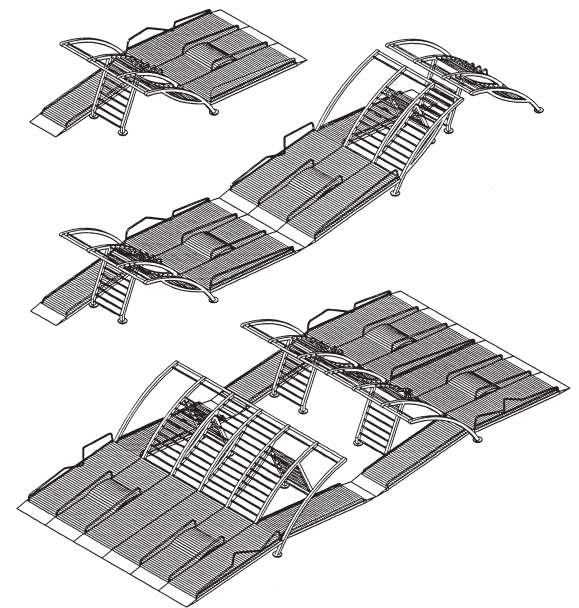
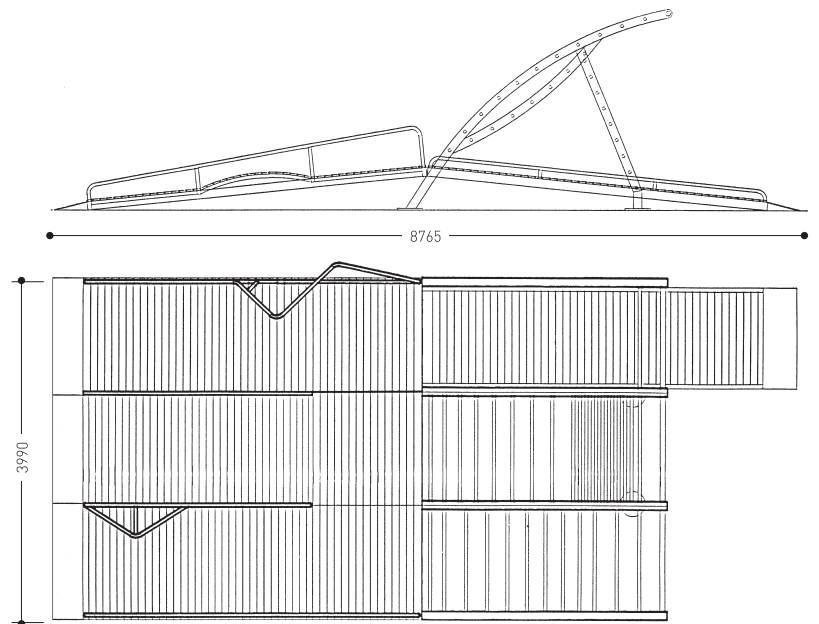

SISTEMA MODULAR / MODULAR SYSTEM



Trot

Xavier Dols

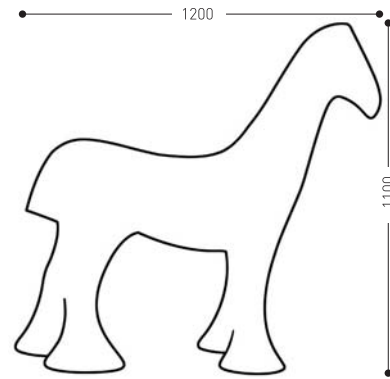

ANCHO 600mm  
PESO 15Kg



**MOBILIARIO URBANO / URBAN FURNITURE**

MOBILIER URBAIN

обустройство городского ландшафта

街道设施

اثات خارجى للمدن

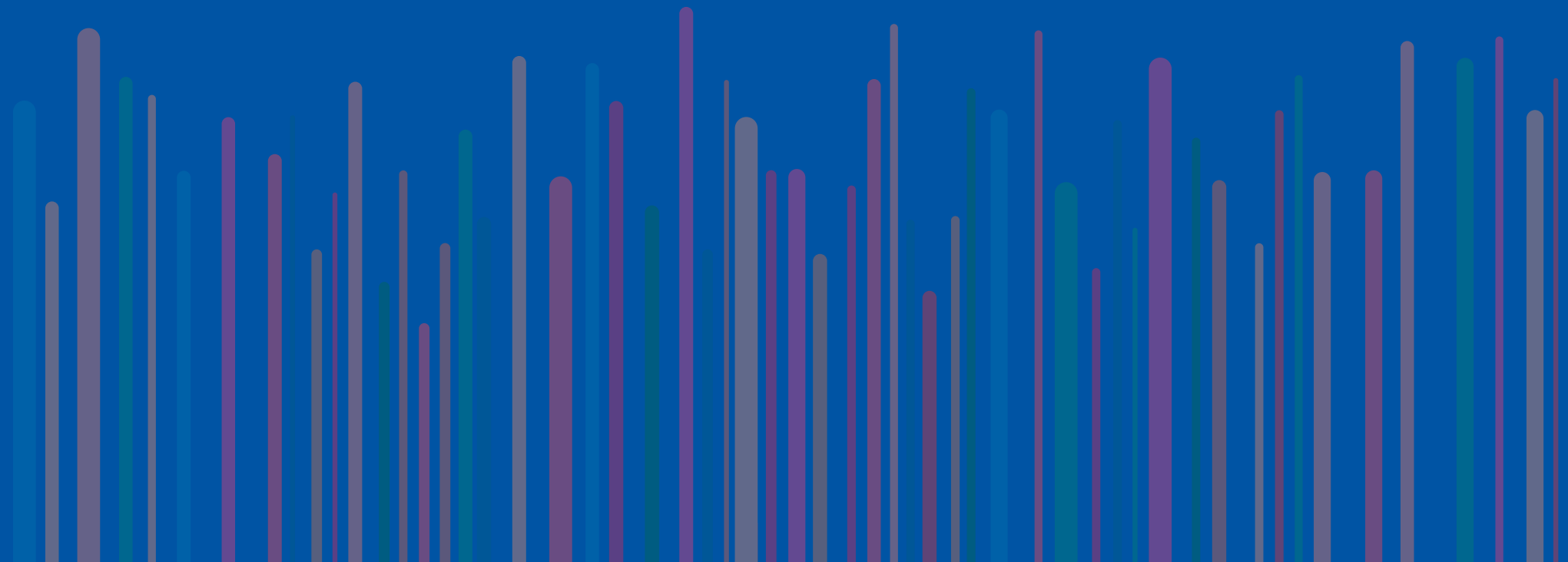



## Modular D3

Antoni Roselló

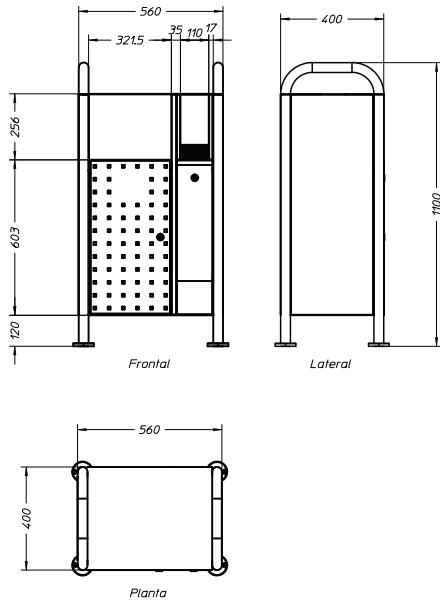

### MODELOS / MODELS / MODÈLES

#### SIMPLE / SIMPLE / SIMPLE

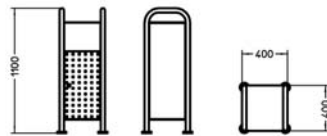

#### ISLA ECOLÓGICA ILE ECOLOGIQUE

#### DOBLE + CENICERO DOUBLE + ASHTRAY DOUBLE + CENDRIER

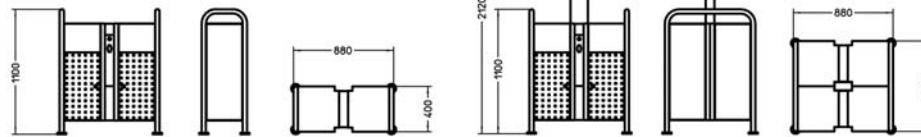



Arco



Quadrat

Antoni Roselló



Oval



Eco-HO

Antoni Roselló





**TR3S**

Antoni Roselló



**Maragall**

Esteva



**MADERA RECICLADA  
RECYCLED WOOD  
BOIS RECYCLÉ**

70% MADERA 30% POLÍMERO  
100% RECICLABLE "cradle to cradle"



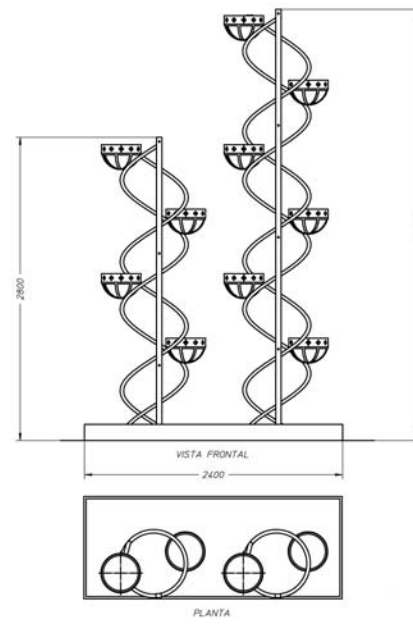

Helix

Esteva



jarDNA

Bea Goller





## Paloalto

Antoni Roselló



## Metropolis

Antoni Roselló





Mupi

Esteva



Darder

Esteva



Trade

Antoni Roselló





Special Signal

FAD



Monolito elíptico

Esteva

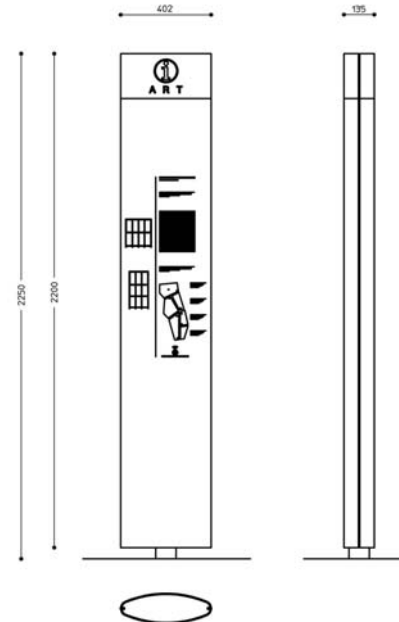



Panel Horizonte

Esteva



Bataller

Esteva





Spirobike

Cercolbike



Rondobike

7Bike



SOMBRA / SHADOW

OMBRE

ТЕНТЫ

遮阳设施

ظلال

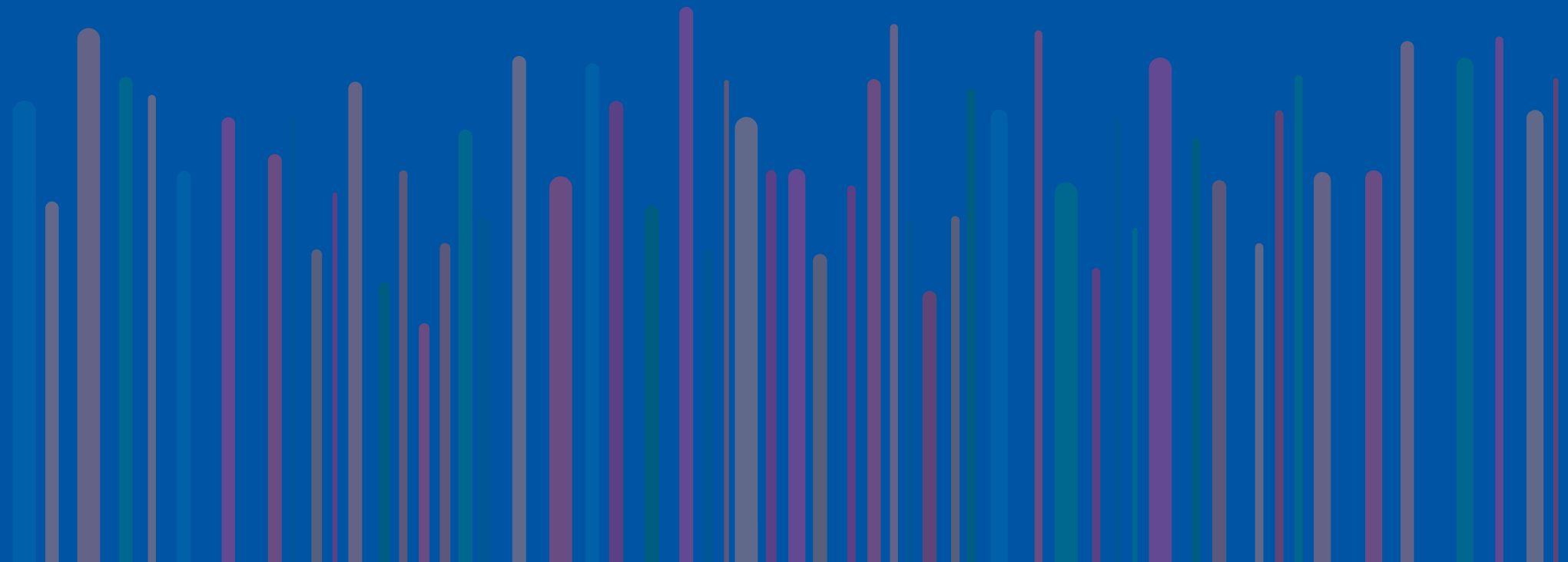



BB  
Esteva



Salou  
Esteva





Vegetal

Esteva

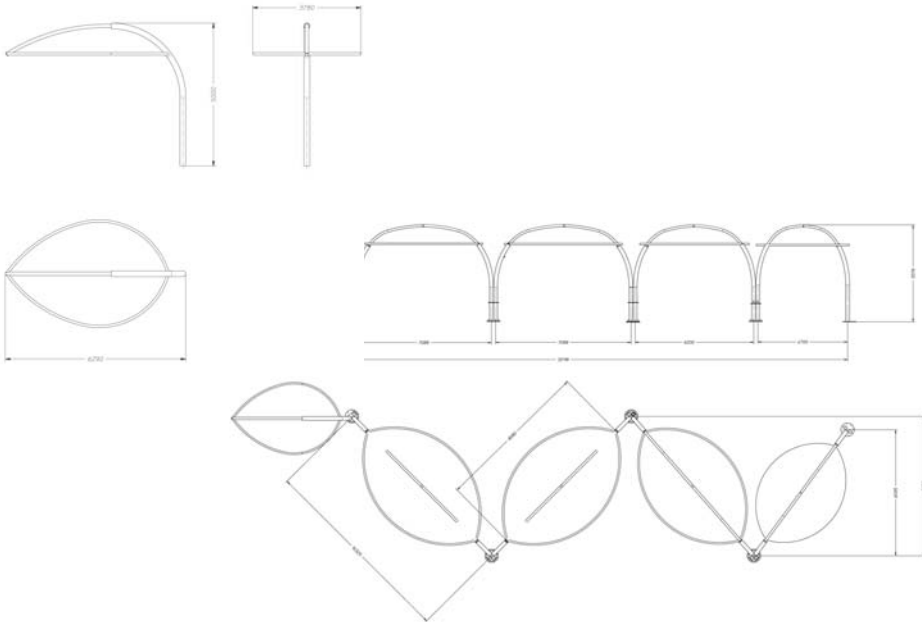



# Eco Basket

Esteva

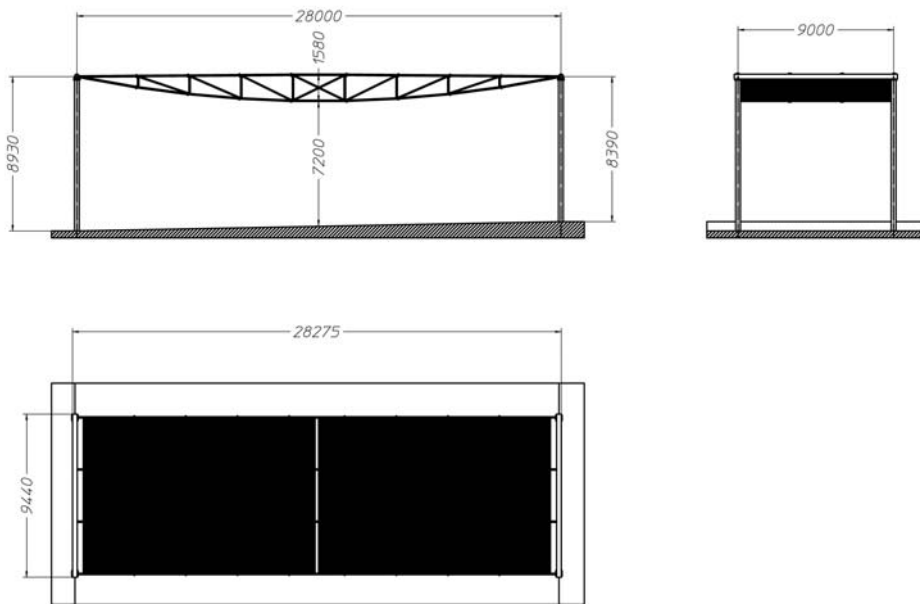



Blob

Imel Sierra

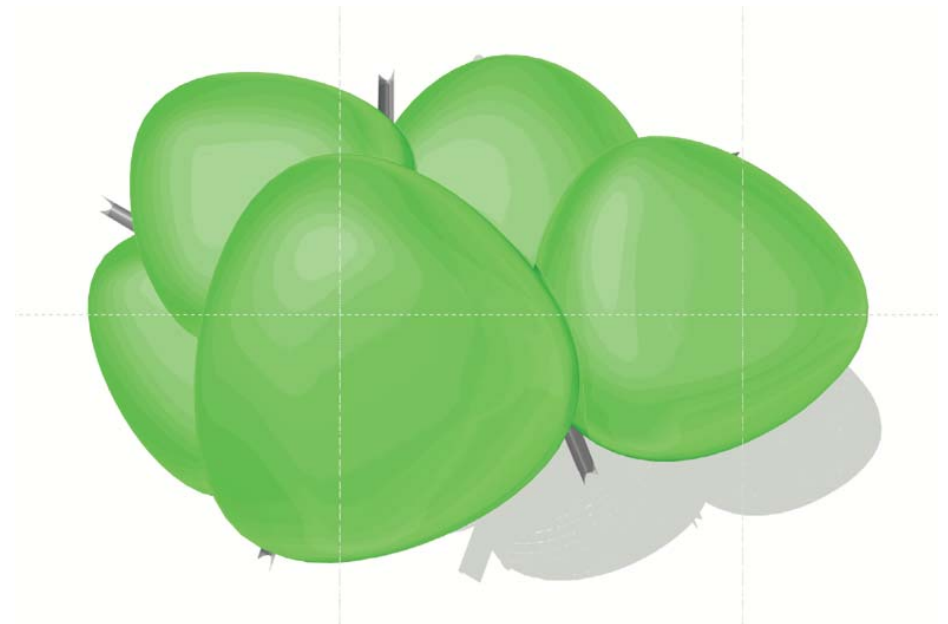



Roselló

Antoni Roselló



Tram



Arroyo



Basik



ARTE PÚBLICO / PUBLIC ART

ART PUBLIC

Арт публика

大众艺术

فنون جماهيرية

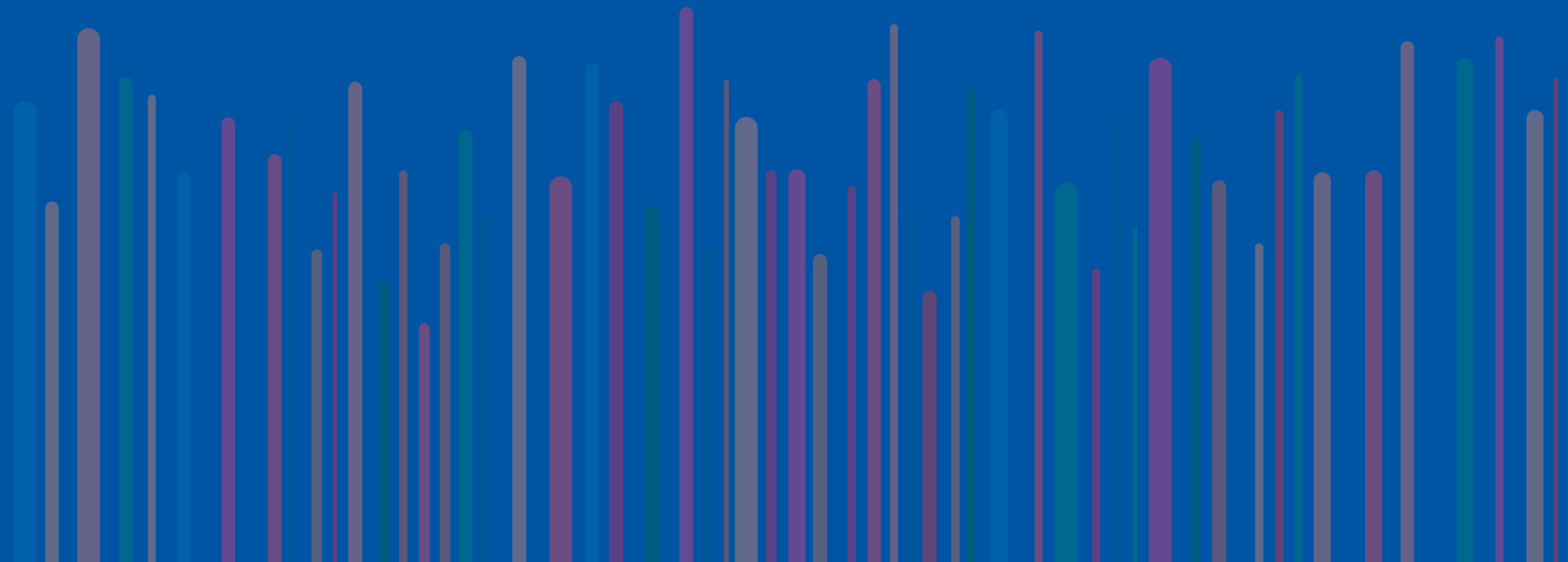



Pink Guins  
Flamingos  
Caracoles  
Aedes

Imel Sierra Cabrera  
[www.imelsierracabrera.com](http://www.imelsierracabrera.com)





Trot  
Jap  
Drom  
Brum

Xavier Dols





## Els Pils, Salou

Antoni Roselló

## La mirada fa el paisatge

Josep Maria Martín



## HISTORIA / HISTORY / HISTORIQUE

- 1957 **Josep Esteva funda un taller de carrocerías de camión en Barcelona.**  
Josep Esteva founds a lorry atelier in Barcelona 1977.  
Josep Esteva fonde une entreprise de carrosserie de camion à Barcelone.
- 1977 **Se incorpora a la empresa la segunda generación Esteva en la administración y se inicia la línea de vehículos especiales para emergencias y elevadores sobre vehículos especiales para cementerios.**  
Second Generation Esteva enters into activity initiating the special vehicles production.  
Arrivée de la deuxième génération de Esteva au sein de l'administration et commence la production de véhicules spéciaux pour les urgences et élévateur spéciaux pour cimetières.
- 1986 **Con motivo del proyecto Olímpico de Barcelona'92 Esteva entra en contacto con el diseñador Antoni Roselló y el escenógrafo Dino Ibañez y se inicia la línea de diseño de equipamiento urbano y la escenografía especial.**  
Esteva enters in contact with designer Antoni Roselló and starts the kiosk production.  
Esteva helps promoting the Barcelona's Olympic candidatures together with scenographer Dino Ibañez and Antoni Roselló and this is the starting point for the scenography Esteva Area.  
Avec pour motivation le projet des jeux Olympiques de Barcelone'92, Esteva entre en contact avec le designer Antoni Roselló et le metteur en scène Dino Ibañez et ainsi commence la production de la ligne de matériel Urbain.
- 1993 **Esteva y Roselló reciben el galardón DELTA DE PLATA ADI FAD por el diseño CONTAINER BAR CONVERTIBLE.**  
Esteva and Roselló get the design SILVER DELTA ADI FAD AWARD for the CONVERTIBLE BAR CONTAINER.  
Esteva et Roselló reçoivent le prix DELTA DE PLATA ADI FAD pour le design du CONTAINER BAR CONVERTIBLE.
- 1997 **Se constituye el departamento de Exportación. Esteva participa en misiones comerciales y de diseño en Arabia Saudita, Argentina, Ucrania, Rusia y Cuba.**  
Esteva starts the export department.  
Création du département Exportation. Esteva participe à des missions commerciales et de design pour les pays d'Arabie Saoudite, Argentine, Ukraine, Russie et Cuba.
- 2003 **Se incorpora a la empresa la tercera generación Esteva especializada en el desarrollo de vehículos para telecomunicaciones y escuderías y proyectos de ingeniería aplicada a todo tipo de productos. Con esta generación llega la sistematización y estandarización de la empresa.**  
Esteva y Roselló reciben el galardón DELTA DE PLATA ADI FAD por el diseño UNIDAD MÓVIL POLIVALENTE.  
Third Esteva Generation enters with standardisation and modernisations of production processes.  
Esteva and Roselló get their second Silver Delta Adi Fad award for the CONVERTIBLE POLIVALENT UNIT.  
Arrivée de la troisième génération d'Esteva spécialisé dans le développement de véhicules de télécommunication et projets d'ingénierie pour tous types de produits. Standardisation des gammes de l'entreprise.  
Esteva et Roselló reçoivent le prix DELTA DE PLATA ADI FAD pour le design UNIDAD MÓVIL POLIVALENTE.
- 2004 **Esteva realiza proyectos de ARTE PÚBLICO en la isla de Puerto Rico.**  
Esteva homologa sus Juegos Infantiles MOWGLI y MIX MIX de acuerdo a las normas UN-1176.  
Esteva standardises games MOWGLI and MIX MIX according to european norm.  
Esteva réalise des projets d'ART PUBLIC sur l'île de Puerto Rico.  
Esteva fait homologuer ses Jeux pour enfants MOWGLI y MIX MIX en accord avec les normes UN-1176.
- 2005 **Esteva diseña y construye las nuevas instalaciones fabriles en Castellbisbal.**  
Esteva projects and builds new atelier in Castellbisbal.  
Esteva design et construit son nouveau centre de fabrication à Castellbisbal.
- 2007 **ESTEVA homologa su elevador sobre vehículo como máquina CE.**  
Esteva standardises elevator on vehicles according to CE machine norm.  
ESTEVA fait homologuer son élévateur sur véhicule comme machine CE.
- 2008 **ESTEVA cumple 50 años y se certifica ISO 9001.**  
50th Aniversary, Esteva standardises processes getting the ISO 9001.  
ESTEVA fête ses 50 ans et se fait certifier ISO 9001.
- 2011 **ESTEVA empieza a trabajar para el Gobierno de Qatar.**  
ESTEVA starts working for Qatar Government.  
ESTEVA à commencé à travailler pour le Gouvernement du Qatar.





### Nuestros Servicios Internacionales:

Diseño, ingeniería y fabricación de productos específicos para cada espacio, logística e instalación en todo el mundo. Proyectos llaves en mano.

### Our International Services:

Design, engineering and manufacturing of specific products for each space, logistics and installation worldwide. Turnkey Projects.

### Nos Services Internationaux:

Conception, d'ingénierie et de fabrication de produits spécifiques pour chaque espace dans le monde entier, de la logistique et l'installation. Projets clés en main.

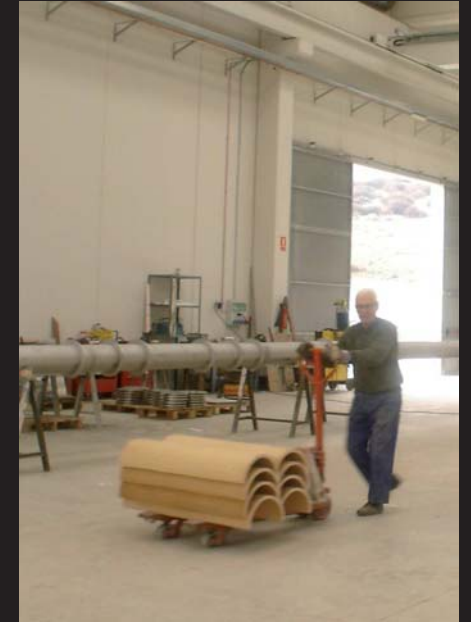

Наша Международная Служба предлагает инженерные услуги и изготовление специфических продуктов для каждого пространства. Предлагаем исполнение проектов под ключ.



我们的服务范围:

每一个空间的特定产品的设计, 工程与制造。一站式方案项目。



خدماتنا الدولية :  
تصميم، مشروعات هندسيه، تصنيع لكل  
منتج بحسب المساحه.  
مشروعات تسليم مفتاح



DEPARTAMENTO TÉCNICO Y FABRICACIÓN  
TECHNICAL DEPARTMENT AND PRODUCTION

Cinemática, 9  
Polígono Industrial Los Herreros  
08755 CASTELLBISBAL  
Barcelona - ESPAÑA  
T. 34 93 772 01 98  
F. 34 93 772 10 49

[esteva@esteva.com](mailto:esteva@esteva.com)  
[www.esteva.com](http://www.esteva.com)

